

The logo for 'eon' is displayed in a bold, blue, rounded font. It is centered within a glowing, golden-yellow, ethereal shape that resembles a stylized flame or a wave of energy. The background consists of horizontal lines, suggesting a window blind or a similar architectural element.

**eon**



DODIRUJEM TE SVAKODNEVNO,  
NAGRAĐUJEŠ ME SVETLOŠĆU I ENERGIJOM, ŽELIM DA TRAJE ..... EON



I TOUCH YOU EVERY DAY,  
REQUIRE ME WITH LIGHT AND ENERGY, I WANT THIS TO LAST ..... EON



Od 1984. kvalitet i pouzdanost su glavni prioriteti u kompaniji Aling-Conel. To se podjednako odnosi na proizvode i usluge. Dugogodišnje iskustvo i brojna priznanja omogućila su nam da postanemo regionalni lider i pouzdan partner našim kupcima.

*Since 1984, quality and reliability are the top priorities of the company Aling-Conel. This applies equally to products and services. Many years of experience and numerous awards have enabled us to become a regional leader and reliable partner to our customers.*



 **ALING-CONEL**



ZAKORAČITE U EON SVET  
ENTER THE EON WORLD

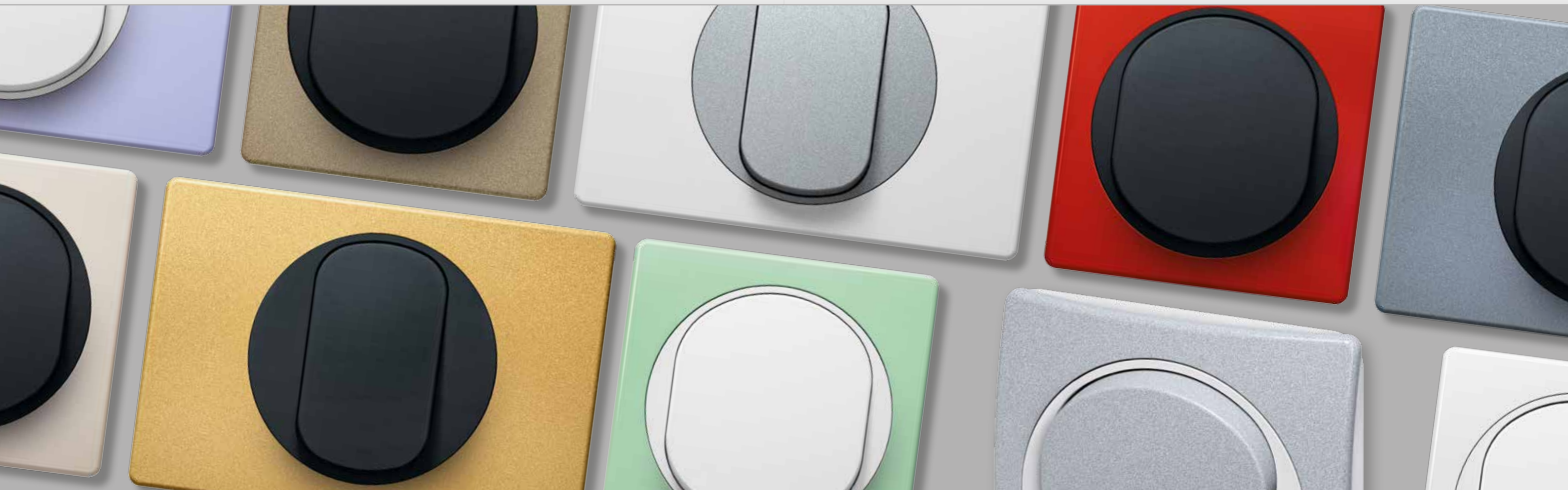

Kombinacija geometrijskih formi kruga i kvadrata kao nova estetska dimenzija.

Odabirom EON programa, oplemenićete Vaš prostor posebnim i jedinstvenim proizvodima.

*The combination of geometric forms of the circle and the square as a new aesthetic dimension.*

*Choosing EON program, you will enrich your space with special and unique products*



U POTPUNOJ HARMONIJI  
SA MODERNIM ZAHTEVIMA DANAŠNJICE

IN COMPLETE HARMONY  
WITH THE MODERN REQUIREMENTS OF TODAY

ŠIROKA PALETA BOJA OMOGUĆAVA VELIKI BROJ KOMBINACIJA  
 WIDE RANGE OF COLORS PROVIDES NUMEROUS COMBINATIONS

MOGUĆNOSTI KOMBINOVANJA  
 POSSIBILITY OF COMBINING

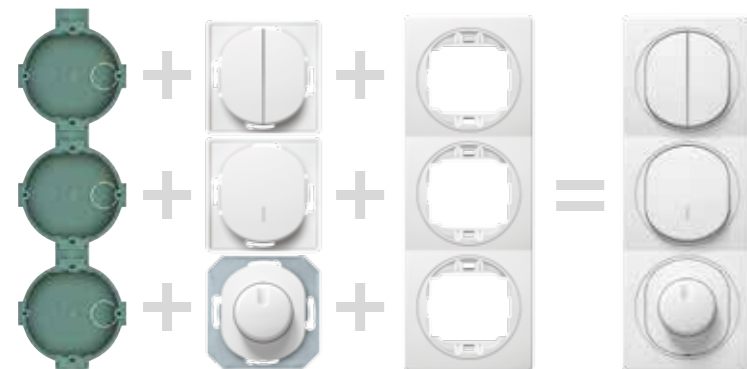
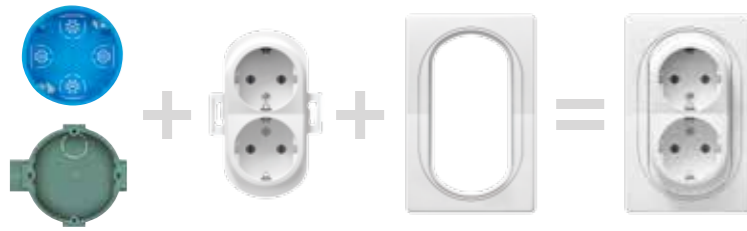
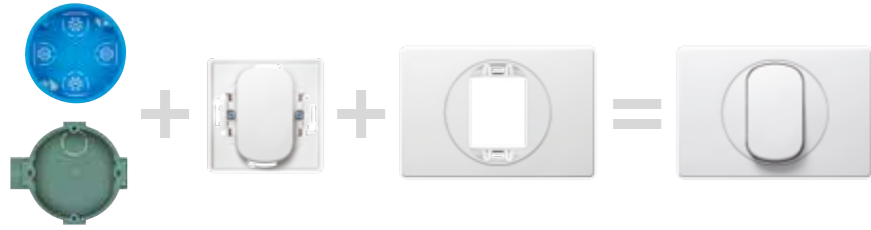
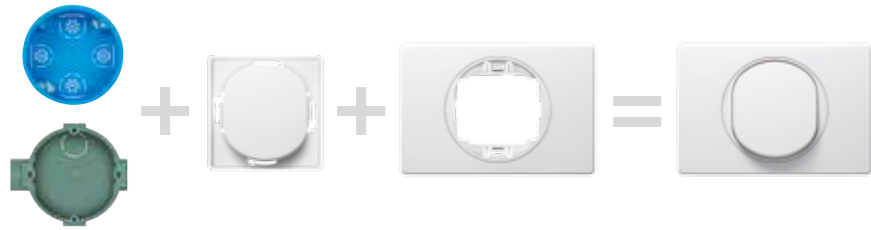
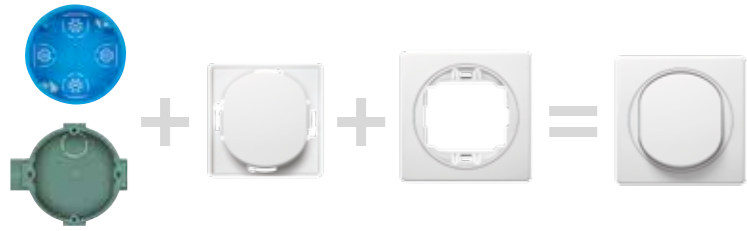

BOJA  
 TASTERA / BLOKA  
 COLOR OF  
 BUTTON / BLOCK



**x = 0**

Bela  
 White  
 RAL 9003



**x = E1**

Crna soft  
 Soft black  
 RAL 7035



**x = S**

Silver  
 Silver



CLASSIC



COLOR



METALLIC



SOFT TOUCH



## TEHNIČKE PREDNOSTI TECHNICAL ADVANTAGES

## BELI PROGRAM SET WHITE PROGRAM SET



### BEZVIJČANA MONTAŽA SCREWLESS INSTALLATION

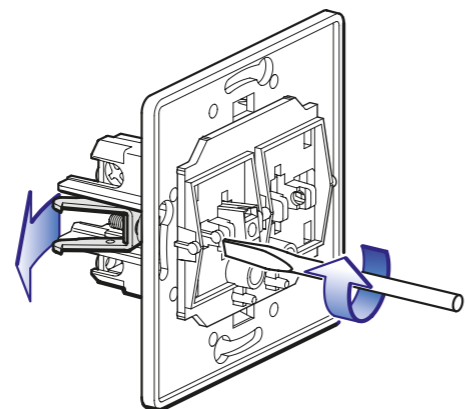

Ugradnja pomoću stegača je brza i jednostavna zahvaljujući rešenju koje omogućava pritezanje stegačem sa vrlo malo okretaja izvijača i bez potrebe jačeg pritezanja vijka.

*The installation by clamps is quick and simple thanks to the solution that provides tightening by clamps with a few screwdriver turnings only and without any necessity for stronger screw tightening.*

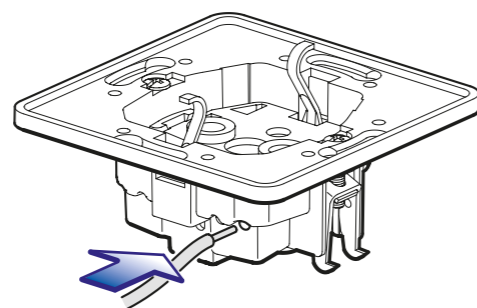
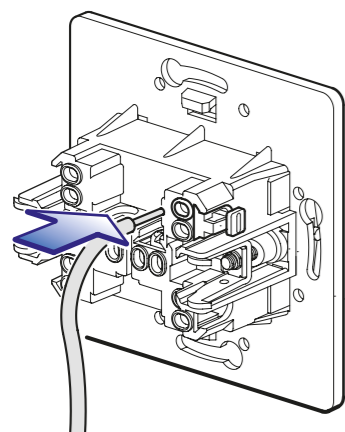

Bezvičajni kontakti omogućuju pouzdanu i brzu montažu do dva provodnika preseka 2,5mm<sup>2</sup>, bez upotrebe alata za stezanje.

*Screwless contacts are allowing safe and fast installation up to two conductors with diameter 2,5mm<sup>2</sup>, without screwdriver.*

### VIJČANA MONTAŽA INSTALLATION WITH SCREWS

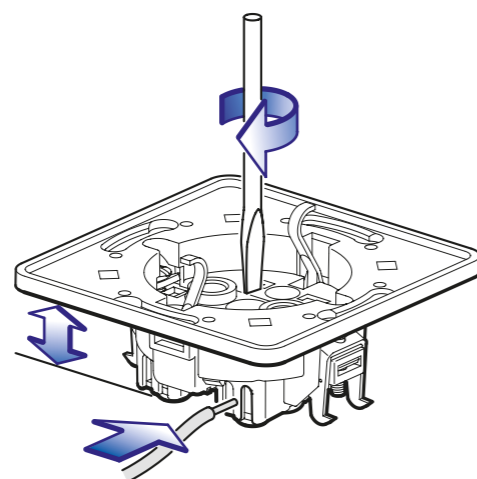
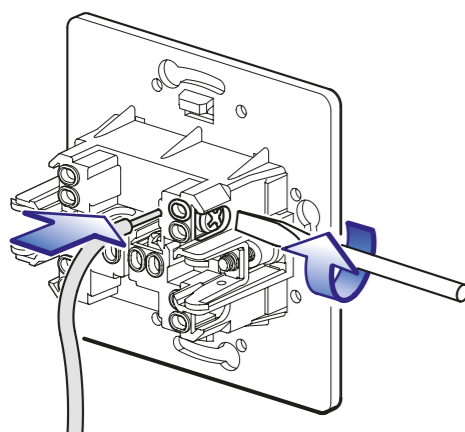

Priključnica je izrađena tako da zauzima veoma malo prostora u montažnoj kutiji čime se montaža pojednostavljuje zbog većeg prostora za smeštaj provodnika. Priključivanje provodnika je veoma brzo jer je obezbeđeno njegovo postavljanje bez mogućnosti isklizavanja tokom pritezanja.

*Socket outlet is made to take a very little space in installation box. Installation is simple because of enough space for conductors. Connecting of wires is fast since there is no possibility of slipping out when tightening.*

Pritezanje provodnika obezbeđeno je pouzdanom i sigurnom vijčanom vezom za provodnike preseka do 4 mm<sup>2</sup>. Priključivanje provodnika je veoma brzo jer je obezbeđeno njegovo postavljanje bez mogućnosti isklizavanja tokom pritezanja.

*The tightening of conductors is provided by the reliable and safe screw joint for the conductors section to 4 mm<sup>2</sup>. The connecting of conductors is very quick as their setting up is secured without any possibility of slipping out during tightening.*



U ponudi programa EON izdvajamo setove proizvoda u beloj boji, dimenzija 80x80mm (mehanizam + dekorativna maska).

Jednostavnost forme i sjajni efekat bele boje čine ovaj set pogodnim za sve prostore.

*EON program in white color, dimensions 80x80, is produced as a set (product without decorative frame + decorative frame).*

*Simplicity of shape and glossy effect of white color makes this set suitable for all spaces.*



## SKLOPKE SWITCHES

- Usaglašeno sa IEC 60669-1,
- Ugradnja u zid u montažnu kutiju Ø60 pomoću stegača ili vijaka

- Complied with IEC 60669-1,
- Wall mounted into the installation box Ø60 by clamps or screws



**E605.00**  
Sklopka jednopolna  
10AX/250V~  
*Single-pole switch  
10AX/250V~*



**E608.00**  
Sklopka ukrсна  
10AX/250V~  
*Cross-switch  
10AX/250V~*



**E6052.00**  
Sklopka dvopolna  
10AX/250V~  
*Double-pole switch  
10AX/250V~*



**E609.00**  
Taster sklopka za svetlo  
bez indikacije  
10AX/250V~  
*Light push-button switch  
without indication  
10AX/250V~*



**E606.00**  
Sklopka serijska  
10AX/250V~  
*Serial switch  
10AX/250V~*



**E6091.00**  
Taster sklopka za svetlo  
sa indikacijom 10AX/250V~  
*Light push-button switch  
with indication 10AX/250V~*

- Indikacija svetli kada je sklopka isključena
- *Indication turns on when the switch is off*



**E607.00**  
Sklopka naizmjenična  
10AX/250V~  
*Alternative switch  
10AX/250V~*



**E610.00**  
Taster sklopka za zvono  
bez indikacije  
10AX/250V~  
*Bell push-button switch  
without indication  
10AX/250V~*



**E6072.00**  
Sklopka naizmjenična  
dvostruka 10AX/250V~  
*Alternative switch  
double 10AX/250V~*



**E6101.00**  
Taster sklopka za zvono  
sa indikacijom 10AX/250V~  
*Bell push-button switch  
with indication 10AX/250V~*

- Indikacija svetli kada je sklopka isključena
- *Indication turns on when the switch is off*



**E6075.00**  
Taster sklopka za roletne  
10AX/250V~  
*Push-button shutters switch  
10AX/250V~*

- Upravljanje kretanjem elektromotora za roletne u dva smera
- *Control of shutters' electric motor movement in two directions*



**E6090.00**  
Taster sklopka  
10AX/250V~  
*Push-button switch  
10AX/250V~*



**E625.00**  
Sklopka jednopolna  
sa indikacijom 10AX/250V~  
*Single-pole switch  
with indication 10AX/250V~*

- Indikacija svetli kada je sklopka isključena
- *Indication turns on when the switch is off*



**E626.00**  
Sklopka serijska  
sa indikacijom 10AX/250V~  
*Serial switch  
with indication 10AX/250V~*

- Indikacija svetli kada je sklopka isključena
- *Indication turns on when the switch is off*



**E627.00**  
Sklopka naizmjenična  
sa indikacijom 10AX/250V~  
*Alternative switch  
with indication 10AX/250V~*

- Indikacija svetli kada je strujno kolo otvoreno
- *Indication turns on when the circuit is open*



**E628.00**  
Sklopka ukrсна  
sa indikacijom 10AX/250V~  
*Cross switch  
with indication 10AX/250V~*

- Indikacija svetli kada je strujno kolo otvoreno
- *Indication turns on when the circuit is open*



**E619.00**  
Sklopka jednopolna  
sa indikacijom 16AX/250V~  
*Single-pole switch  
with indication 16AX/250V~*

- Indikacija svetli kada je sklopka isključena
- *Indication turns on when the switch is off*



**E6191.00**  
Sklopka jednopolna  
indikatorska 16AX/250V~  
*Single-pole switch  
with indication 16AX/250V~*

- Indikacija svetli kada je sklopka uključena
- *Indication turns on when the switch is on*

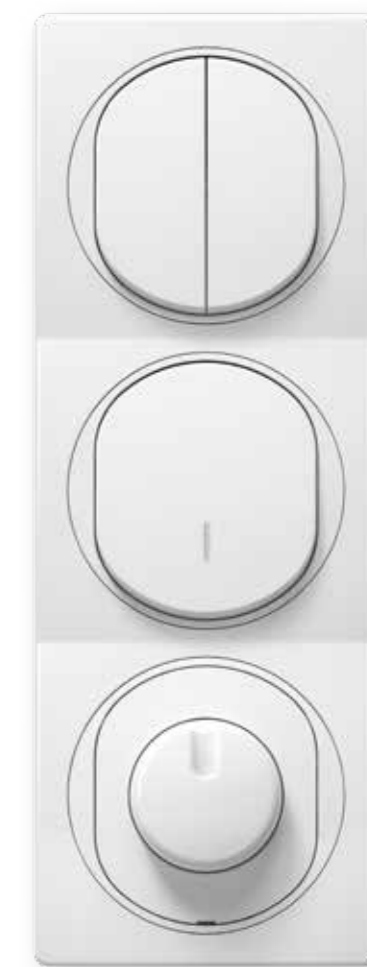



**E617.00**

Regulator jačine svetlosti sa naizmeničnom sklopkom 40-400VA, 230V~/50Hz

*Dimmer with alternative switch 40-400VA, 230V~/50Hz*

- Za sijalice sa užarenim vlaknom i halogene sijalice sa standardnim transformatorom,
- Usaglašeno sa IEC 60669-2-1
- Ugradnja u zid u montažnu kutiju Ø60 pomoću stegača ili vijaka

- *For incandescent filament lamps and halogen lamps with standard transformer*
- *Complied with IEC 60669-2-1*
- *Wall mounted into the installation box Ø60 by clamps or screws*



**E6173.00**

Regulator jačine svetlosti sa rotacionom jednopolnom sklopkom 40-400VA, 230V~/50Hz

*Dimmer with rotary single-pole switch 40-400VA, 230V~/50Hz*

- Za sijalice sa užarenim vlaknom i halogene sijalice sa standardnim transformatorom,
- Usaglašeno sa IEC 60669-2-1
- Ugradnja u zid u montažnu kutiju Ø60 pomoću stegača ili vijaka

- *For incandescent filament lamps and halogen lamps with standard transformer*
- *Complied with IEC 60669-2-1*
- *Wall mounted into the installation box Ø60 by clamps or screws*



**E6175.00**

Regulator jačine svetlosti za LED, 100W

*Dimmer for LED, 100W*

- Univerzalni elektronski regulator za sve vrste sijalica;
- Osnovna namena za CFL i LED dimabilne sijalice 0-100W;
- Usaglašeno sa IEC 60669-2-1

- *Universal dimmer for all types of bulbs;*
- *The main purpose for dimmable CFL and LED bulbs 0-100W;*
- *Complied with IEC 60669-2-1*



**E600.00**

Priključnica dvopolna 16A/250V- sa porcelanskim jezgrom

*Double-pole socket outlet 16A/250V- with porcelain insert*



**E601.00**

Priključnica dvopolna 16A/250V- sa porcelanskim jezgrom i zaštitom kontakta

*Double-pole socket outlet 16A/250V- with porcelain insert and touch protection*



**E630.00**

Priključnica dvopolna 16A/250V- sa polikarbonatskim jezgrom

*Double-pole socket outlet 16A/250V- with polycarbonate insert*



**E603.00**

Priključnica dvopolna sa poklopcem 16A/250V- sa porcelanskim jezgrom

*Double-pole socket outlet with cover 16A/250V- with porcelain insert*



**E633.00**

Priključnica dvopolna sa poklopcem 16A/250V- sa polikarbonatskim jezgrom

*Double-pole socket outlet with cover 16A/250V- with polycarbonate insert*



**E604.00**

Priključnica dvopolna dupla 16A/250V- sa polikarbonatskim jezgrom

*Double-pole socket outlet 16A/250V- dual with polycarbonate insert*

- Nema mogućnost ugradnje u višestruke maske
- *No possibility of mounting into multi-gang masks*



## KOMUNIKACIJE COMMUNICATIONS

- Usaglašeno sa IEC 60603-7.
- Ugradnja u zid u montažnu kutiju Ø60 pomoću stegača ili vijaka
- Complied with IEC 60603-7.
- Wall mounted into the installation box Ø60 by clamps or screws



### E6161.00

USB punjač 2xUSB  
1,2A 5V=  
2xUSB charger  
1,2A 5V=

- Za punjenje elektronskih uređaja putem standardnog USB porta;
- Punjenje dva uređaja istovremeno;
- Usaglašeno sa EN 60950-1 i EMC direktivom;
- Ugradnja u zid u montažnu kutiju Ø60 pomoću stegača ili vijaka
- For charging of electronic devises via standard USB port;
- Enables charging of two devices simultaneously;
- Complied with EN 60950-1 and EMC directive;
- Wall mounted into the installation box Ø60 by clamps or screws



### E613.00

Priključnica telefonska dvostruka sa Keystone modulima 2xRJ12 6/4 Cat 3  
Double telephone socket with Keystone modules 2xRJ12 6/4 Cat 3



### E6131.00

Priključnica telefonska dvostruka sa Keystone modulima 2xRJ 12 6/6 Cat 3  
Double telephone socket with Keystone modules 2xRJ12 6/6 Cat 3

- Montaža provodnika bez upotrebe alata
- Tool - less conducting wire installation



### E6162.00

Priključnica USB/USB Keystone  
USB/USB socket  
Keystone

- Za konekciju USB uređaja i kablova (nije punjač);
- Podržava USB 2.0 standard;
- Ugradnja u zid u montažnu kutiju Ø60 pomoću stegača ili vijaka
- For connection of USB devices and cables (not charging unit);
- Supports USB 2.0 standard;
- Wall mounted into the installation box Ø60 by clamps or screws



### E614.00

Priključnica komunikacijska dvostruka sa Keystone modulima 2xRJ45 Cat 5e UTP  
Double data socket with Keystone modules 2xRJ45 Cat 5e UTP

- Montaža provodnika bez upotrebe alata
- Spajanje prema TIA/EIA-568A ili 568B standardu za raspored parica
- Tool - less conducting wire installation
- Wiring according to TIA/EIA-568A or 568B standard for the arrangement of pairs



### E614S.00

Priključnica komunikacijska dvostruka sa Keystone modulima 2xRJ45 Cat 5e FTP  
Double data socket with Keystone modules 2xRJ45 Cat 5e FTP (shielded)

- Montaža provodnika bez upotrebe alata
- Spajanje prema TIA/EIA-568A ili 568B standardu za raspored parica
- Tool - less conducting wire installation
- Wiring according to TIA/EIA-568A or 568B standard for the arrangement of pairs



### E6163.00

Priključnica HDMI/HDMI Keystone  
HDMI/HDMI socket  
Keystone

- Za konekciju kablova za prenos signala preko HDMI priključka;
- Ugradnja u zid u montažnu kutiju Ø60 pomoću stegača ili vijaka
- For the transmission of signal through HDMI connector;
- Wall mounted into the installation box Ø60 by clamps or screws



### E615.00

Priključnica komunikacijska dvostruka sa Keystone modulima 2xRJ45 Cat 6 UTP  
Double data socket with Keystone modules 2xRJ45 Cat 6 UTP

- Montaža provodnika bez upotrebe alata
- Spajanje prema TIA/EIA-568A ili 568B standardu za raspored parica
- Tool - less conducting wire installation
- Wiring according to TIA/EIA-568A or 568B standard for the arrangement of pairs



### E615S.00

Priključnica komunikacijska dvostruka sa Keystone modulima 2xRJ45 Cat 6 FTP  
Double data socket with Keystone modules 2xRJ45 Cat 6 FTP (shielded)

- Montaža provodnika bez upotrebe alata
- Spajanje prema TIA/EIA-568A ili 568B standardu za raspored parica
- Tool - less conducting wire installation
- Wiring according to TIA/EIA-568A or 568B standard for the arrangement of pairs



### E616.00

Priključnica komunikacijska sa Keystone modulom RJ45 Cat 6A UTP  
Data socket with Keystone module RJ45 Cat 6A UTP

- Montaža provodnika bez upotrebe alata
- Spajanje prema TIA/EIA-568A ili 568B standardu za raspored parica
- Tool - less conducting wire installation
- Wiring according to TIA/EIA-568A or 568B standard for the arrangement of pairs



### E616S.00

Priključnica komunikacijska sa Keystone modulom RJ45 Cat 6A FTP  
Data socket with Keystone module RJ45 Cat 6A FTP (shielded)

- Montaža provodnika bez upotrebe alata
- Spajanje prema TIA/EIA-568A ili 568B standardu za raspored parica
- Tool - less conducting wire installation
- Wiring according to TIA/EIA-568A or 568B standard for the arrangement of pairs



- Usaglašeno sa IEC 60169-2,
- Ugradnja u zid u montažnu kutiju Ø60 pomoću stegača ili vijaka

- Complied with IEC 60169-2,
- Wall mounted into the installation box Ø60 by clamps or screws



**E6121.00**

Priključnica antenska TV završna za individualne sisteme

*TV aerial socket for individual systems*

- Muški konektor,
- Odvodno slabljenje signala <1 dB

- Male connector,
- Connection attenuation <1 dB



**E612P.00**

Priključnica antenska TV/FM prolazna

*TV/FM aerial socket transient*

- Muški konektor TV, ženski konektor FM,
- Prolazno slabljenje 4 dB, odvodno 6 dB, sprega TV/FM >20 dB

- Male connector TV, female connector FM,
- Throughpass attenuation 4 dB, connection atten. 6 dB, coupling TV/FM >20 dB



**E612Z.00**

Priključnica antenska TV/FM završna

*TV/FM aerial socket terminal*

- Muški konektor TV, ženski konektor FM,
- Odvodno slabljenje <2 dB, sprega TV/FM >20 dB

- Male connector TV, female connector FM,
- Connection attenuation <2 dB, coupling attenuation TV/FM >20 dB



**E612S.00**

Priključnica antenska TV/FM/SAT završna

*TV/FM/SAT aerial socket terminal*

- Muški konektor TV, ženski konektor FM,
- SAT konektor IEC 60169-24 (F tip),
- Odvodno slabljenje <2 dB, sprega TV/FM >20 dB

- Male connector TV, female connector FM,
- SAT connector IEC 60169-24 (F type),
- Connection attenuation <2 dB, coupling attenuation TV/FM >20 dB



Proizvodi bez maske proizvode se u tri boje: beloj, crnoj soft i silver.

Korisnik je u mogućnosti da kombinuje boje sa dekorativnim maskama po sopstvenoj želji.

*Products without decorative frame are produced in three colors: white, soft black and silver.*

*The user is able to combine color with decorative frames as desired.*

- Usaglašeno sa IEC 60669-1,
- Ugradnja u zid u montažnu kutiju Ø60 pomoću stegača ili vijaka

- Complied with IEC 60669-1,
- Wall mounted into the installation box Ø60 by clamps or screws

■ Bela White **x = 0**

■ Crna soft Soft black **x = E1**

■ Silver Silver **x = S**



**E605.x**  
Sklopka jednopolna  
10AX/250V~  
*Single-pole switch  
10AX/250V~*

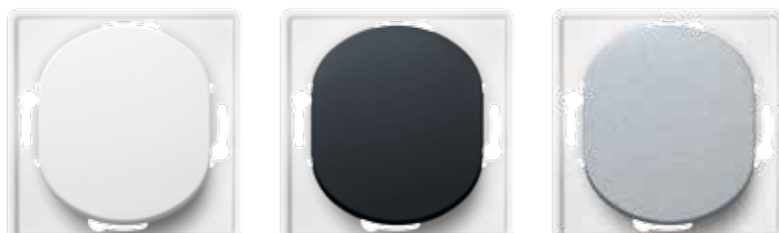

**E6052.x**  
Sklopka dvopolna  
10AX/250V~  
*Double-pole switch  
10AX/250V~*

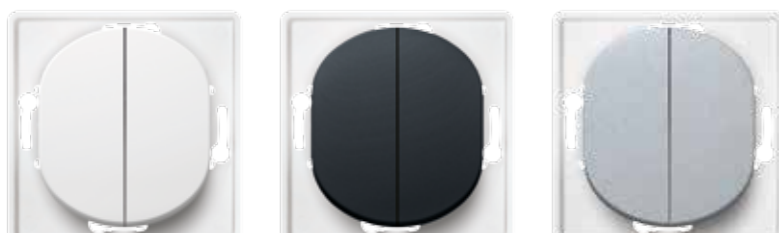

**E606.x**  
Sklopka serijska  
10AX/250V~  
*Serial switch  
10AX/250V~*

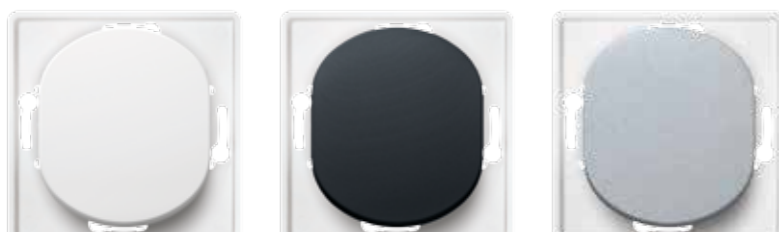

**E607.x**  
Sklopka naizmjenična  
10AX/250V~  
*Alternative switch  
10AX/250V~*

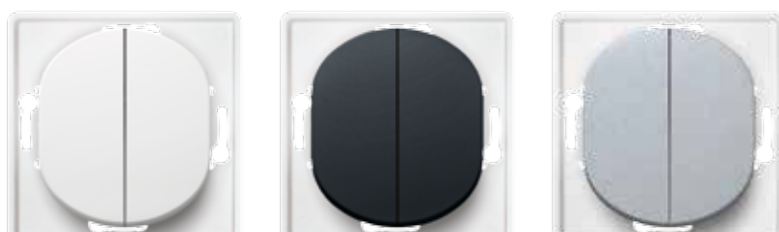

**E6072.x**  
Sklopka naizmjenična  
dvostruka 10AX/250V~  
*Alternative switch double  
10AX/250V~*

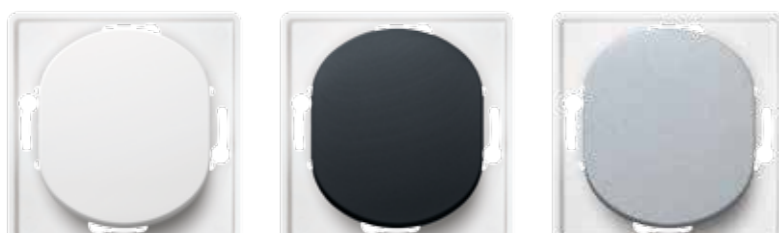

**E608.x**  
Sklopka ukrсна  
10AX/250V~  
*Cross-switch  
10AX/250V~*



**E6090.x**  
Taster sklopka  
10AX/250V~  
*Push-button switch  
10AX/250V~*



**E609.x**  
Taster sklopka za svetlo  
bez indikacije  
10AX/250V~  
*Light push-button switch  
without indication  
10AX/250V~*



**E6091.x**  
Taster sklopka za svetlo  
sa indikacijom 10AX/250V~  
*Light push-button switch  
with indication 10AX/250V~*

- Indikacija svetli kada je sklopka isključena
- Indication turns on when the switch is off



**E610.x**  
Taster sklopka za zvono  
bez indikacije  
10AX/250V~  
*Bell push-button switch  
without indication  
10AX/250V~*

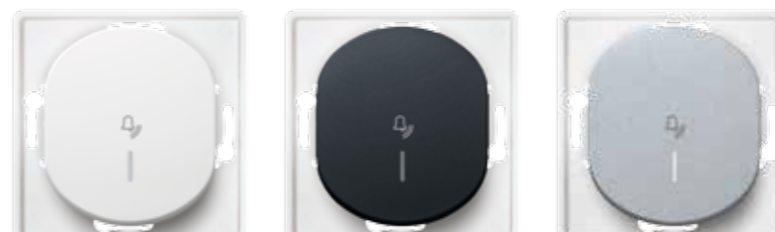

**E6101.x**  
Taster sklopka za zvono  
sa indikacijom 10AX/250V~  
*Bell push-button switch  
with indication 10AX/250V~*

- Indikacija svetli kada je sklopka isključena
- Indication turns on when the switch is off



**E6075.x**  
Taster sklopka za roletne  
10AX 250V~  
*Push-button shutters switch  
10AX 250V~*

- Upravljanje kretanjem elektromotora za roletne u dva smera
- Control of shutters' electric motor movement in two directions

- Usaglašeno sa IEC 60669-1,
- Ugradnja u zid u montažnu kutiju Ø60 pomoću stegača ili vijaka

- Complied with IEC 60669-1,
- Wall mounted into the installation box Ø60 by clamps or screws

Bela  
White **x = 0**

Crna soft  
Soft black **x = E1**

Silver  
Silver **x = S**

- Usaglašeno sa IEC 60669-2-1
- Ugradnja u zid u montažnu kutiju Ø60 pomoću stegača ili vijaka

- Complied with IEC 60669-2-1
- Wall mounted into the installation box Ø60 by clamps or screws



### E625.x

Sklopka jednopolna sa indicijom 10AX/250V~  
*Single-pole switch with indication 10AX/250V~*

- Indikacija svetli kada je sklopka isključena
- Indication turns on when the switch is off

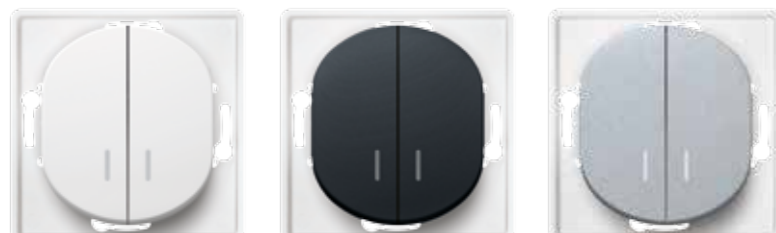

### E626.x

Sklopka serijska sa indicijom 10AX/250V~  
*Serial switch with indication 10AX/250V~*

- Indikacija svetli kada je sklopka isključena
- Indication turns on when the switch is off



### E627.x

Sklopka naizmjenična sa indicijom 10AX/250V~  
*Alternative switch with indication 10AX/250V~*

- Indikacija svetli kada je strujno kolo otvoreno
- Indication turns on when the circuit is open

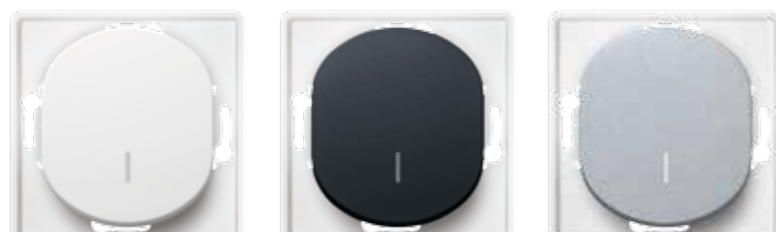

### E628.x

Sklopka ukrсна sa indicijom 10AX/250V~  
*Cross switch with indication 10AX/250V~*

- Indikacija svetli kada je strujno kolo otvoreno
- Indication turns on when the circuit is open



### E619.x

Sklopka jednopolna sa indicijom 16AX/250V~  
*Single-pole switch with indication 16AX/250V~*

- Indikacija svetli kada je strujno kolo otvoreno
- Indication turns on when the circuit is open



### E6191.x

Sklopka jednopolna indikatorska 16AX/250V~  
*Single-pole switch with indication 16AX/250V~*

- Indikacija svetli kada je sklopka uključena
- Indication turns on when the switch is on



### E617.x

Regulator jačine svetlosti sa naizmjeničnom sklopkom 40-400VA, 230V~/50Hz  
*Dimmer with alternative switch 40-400VA, 230V~/50Hz*

- Za sijalice sa užarenim vlaknom i halogene sijalice sa standardnim transformatorom,
- For incandescent filament lamps and halogen lamps with standard transformer



### E6173.x

Regulator jačine svetlosti sa rotacionom jednopolnom sklopkom 40-400VA, 230V~/50Hz  
*Dimmer with rotary single-pole switch 40-400VA, 230V~/50Hz*

- Za sijalice sa užarenim vlaknom i halogene sijalice sa standardnim transformatorom,
- For incandescent filament lamps and halogen lamps with standard transformer



### E6175.x

Regulator jačine svetlosti za LED, 100W  
*Dimmer for LED, 100W*

- Univerzalni elektronski regulator za sve vrste sijalica;
- Osnovna namena za CFL i LED dimabilne sijalice 0-100W;
- Universal dimmer for all types of bulbs;
- The main purpose for dimmable CFL and LED bulbs 0-100W;

# USKI TASTER NARROW BUTTON

- Usaglašeno sa IEC 60669-1,
- Ugradnja u zid u montažnu kutiju Ø60 pomoću stegača ili vijaka

- Complied with IEC 60669-1,
- Wall mounted into the installation box Ø60 by clamps or screws

■ Bela  
White **x = 0**

■ Crna soft  
Soft black **x = E1**

■ Silver  
Silver **x = S**



## E605U.x

Sklopka jednopolna  
10AX/250V~  
*Single-pole switch  
10AX/250V~*



## E6052U.x

Sklopka dvopolna  
10AX/250V~  
*Double-pole switch  
10AX/250V~*



## E607U.x

Sklopka naizmjenična  
10AX/250V~  
*Alternative switch  
10AX/250V~*



## E608U.x

Sklopka ukrсна  
10AX/250V~  
*Cross-switch  
10AX/250V~*



## E6090U.x

Taster sklopka  
10AX/250V~  
*Push-button switch  
10AX/250V~*



## E609U.x

Taster sklopka za svetlo  
bez indikacije  
10AX/250V~  
*Light push-button switch  
without indication  
10AX/250V~*



## E609IU.x

Taster sklopka za svetlo  
sa indikacijom 10AX/250V~  
*Light push-button switch  
with indication 10AX/250V~*

- Indikacija svetli kada je sklopka isključena
- *Indication turns on when the switch is off*



## E610U.x

Taster sklopka za zvono  
bez indikacije  
10AX/250V~  
*Bell push-button switch  
without indication  
10AX/250V~*



## E610IU.x

Taster sklopka za zvono  
sa indikacijom 10AX/250V~  
*Bell push-button switch  
with indication 10AX/250V~*

- Indikacija svetli kada je sklopka isključena
- *Indication turns on when the switch is off*

# USKI TASTER NARROW BUTTON

- Usaglašeno sa IEC 60669-1,
- Ugradnja u zid u montažnu kutiju Ø60 pomoću stegača ili vijaka

- Complied with IEC 60669-1,
- Wall mounted into the installation box Ø60 by clamps or screws



## E625U.x

Sklopka jednopolna sa indikacijom 10AX/250V~  
*Single-pole switch with indication 10AX/250V~*

- Indikacija svetli kada je sklopka isključena
- Indication turns on when the switch is off



## E627U.x

Sklopka naizmjenična sa indikacijom 10AX/250V~  
*Alternative switch with indication 10AX/250V~*

- Indikacija svetli kada je strujno kolo otvoreno
- Indication turns on when the circuit is open



## E628U.x

Sklopka ukrсна sa indikacijom 10AX/250V~  
*Cross switch with indication 10AX/250V~*

- Indikacija svetli kada je strujno kolo otvoreno
- Indication turns on when the circuit is open



## E619U.x

Sklopka jednopolna sa indikacijom 16AX/250V~  
*Single-pole switch with indication 16AX/250V~*

- Indikacija svetli kada je strujno kolo otvoreno
- Indication turns on when the circuit is open



## E6191U.x

Sklopka jednopolna indikatorska 16AX/250V~  
*Single-pole switch with indication 16AX/250V~*

- Indikacija svetli kada je sklopka uključena
- Indication turns on when the switch is on

	Bela White	<b>x = 0</b>
	Crna soft Soft black	<b>x = E1</b>
	Silver Silver	<b>x = S</b>

- Usaglašeno sa IEC 60884-1,
- Ugradnja u zid u montažnu kutiju Ø60 pomoću stegača ili vijaka

- Complied with IEC 60884-1,
- Wall mounted into the installation box Ø60 by clamps or screws



## E600.x

Priključnica dvopolna 16A/250V~ sa porcelanskim jezgrom  
*Double-pole socket outlet 16A/250V~ with porcelain insert*



## E601.x

Priključnica dvopolna 16A/250V~ sa porcelanskim jezgrom i zaštitom od kontakta  
*Double-pole socket outlet 16A/250V~ with porcelain insert and touch protection*



## E630.x

Priključnica dvopolna 16A/250V~ sa polikarbonatskim jezgrom  
*Double-pole socket outlet 16A/250V~ with polycarbonate insert*



## 603.x

Priključnica dvopolna sa poklopcem 16A/250V~ sa porcelanskim jezgrom  
*Double-pole socket outlet with cover 16A/250V~ with porcelain insert*



## E633.x

Priključnica dvopolna sa poklopcem 16A/250V~ sa polikarbonatskim jezgrom  
*Double-pole socket outlet with cover 16A/250V~ with polycarbonate insert*



## E604.x

Priključnica dvopolna dupla 16A/250V~ sa polikarbonatskim jezgrom  
*Double-pole socket outlet 16A/250V~ dual with polycarbonate insert*

- Nema mogućnost ugradnje u višestruke maske
- No possibility of mounting into multi-gang masks

- Usaglašeno sa EN 60950-1 i EMC direktivom;
- Ugradnja u zid u montažnu kutiju Ø60 pomoću stegača ili vijaka

- Complied with EN 60950-1 and EMC directive;
- Wall mounted into the installation box Ø60 by clamps or screws



### E6161.x

USB punjač 2xUSB 1,2A 5V=  
*2xUSB charger 1,2A 5V=*

- Za punjenje elektronskih uređaja putem standardnog USB porta;
- Punjenje dva uređaja istovremeno
- For charging of electronic devices via standard USB port;
- Enables charging of two devices simultaneously



### E6162.x

Priključnica USB/USB Keystone  
*USB/USB socket Keystone*

- Za konekciju USB uređaja i kablova;
- Podržava USB 2.0 standard;
- For connection of USB devices and cables;
- Supports USB 2.0 standard;



### E6163.x

Priključnica HDMI/HDMI Keystone  
*HDMI/HDMI socket Keystone*

- Za konekciju kablova za prenos signala preko HDMI priključka;
- For the transmission of signal through HDMI connector;

- Usaglašeno sa IEC 60603-7;
- Ugradnja u zid u montažnu kutiju Ø60 pomoću stegača ili vijaka

- Complied with IEC 60603-7;
- Wall mounted into the installation box Ø60 by clamps or screws



### E613.x

Priključnica telefonska dvostruka sa Keystone modulima 2xRJ12 6/4 Cat 3

*Double telephone socket with Keystone modules 2xRJ12 6/4 Cat 3*



### E6131.x

Priključnica telefonska dvostruka sa Keystone modulima 2xRJ12 6/6 Cat 3

*Double telephone socket with Keystone modules 2xRJ12 6/6 Cat 3*

- Montaža provodnika bez upotrebe alata
- Toll - less conducting wire installation

- Usaglašeno sa IEC 60603-7;
- Montaža provodnika bez upotrebe alata;
- Spajanje prema TIA/EIA-568A ili 568B standardu za raspored parica;
- Ugradnja u zid u montažnu kutiju Ø60 pomoću stegača ili vijaka

- Complied with IEC 60603-7;
- Toll - less conducting wire installation
- Wiring according to TIA/EIA-568A or 568B standard for the arrangement of pairs
- Wall mounted into the installation box Ø60 by clamps or screws



### E614.x

Priključnica komunikacijska dvostruka sa Keystone modulima 2xRJ45 Cat 5e UTP  
*Double data socket with Keystone modules 2xRJ45 Cat 5e UTP*



### E614S.x

Priključnica komunikacijska dvostruka sa Keystone modulima 2xRJ45 Cat 5e FTP

*Double data socket with Keystone modules 2xRJ45 Cat 5e FTP (shielded)*



### E615.x

Priključnica komunikacijska dvostruka sa Keystone modulima 2xRJ45 Cat 6 UTP

*Double data socket with Keystone modules 2xRJ45 Cat 6 UTP*



### E615S.x

Priključnica komunikacijska dvostruka sa Keystone modulima 2xRJ45 Cat 6 FTP

*Double data socket with Keystone modules 2xRJ45 Cat 6 FTP (shielded)*



### E616.x

Priključnica komunikacijska sa Keystone modulom RJ45 Cat 6A UTP

*Data socket with Keystone module RJ45 Cat 6A UTP*



### E616S.x

Priključnica komunikacijska sa Keystone modulom RJ45 Cat 6A FTP

*Data socket with Keystone module RJ45 Cat 6A FTP (shielded)*

- Usaglašeno sa IEC 60169-2,
- Ugradnja u zid u montažnu kutiju Ø60 pomoću stegača ili vijaka

- Complied with IEC 60169-2,
- Wall mounted into the installation box Ø60 by clamps or screws



## DEKORATIVNE MASKE DECORATIVE FRAMES



### E612I.x

Priključnica antenska TV završna za individualne sisteme  
*TV aerial socket for individual systems*

- Muški konektor,
- Odvodno slabljenje signala <1 dB
- Male connector,
- Connection attenuation <1 dB



### E612Z.x

Priključnica antenska TV/FM završna  
*TV/FM aerial socket terminal*

- Muški konektor TV, ženski konektor FM,
- Odvodno slabljenje <2 dB, sprega TV/FM >20 dB
- Male connector TV, female connector FM,
- Connection attenuation <2 dB, coupling attenuation TV/FM >20 dB



### E612P.x

Priključnica antenska TV/FM prolazna  
*TV/FM aerial socket transient*

- Muški konektor TV, ženski konektor FM,
- Prolazno slabljenje 4 dB, odvodno 6 dB, sprega TV/FM >20 dB
- Male connector TV, female connector FM,
- Throughpass attenuation 4 dB, connection atten. 6 dB, coupling TV/FM >20 dB



### E612S.x

Priključnica antenska TV/FM/SAT završna  
*TV/FM/SAT aerial socket terminal*

- Muški konektor TV, ženski konektor FM,
- SAT konektor IEC 60169-24 (F tip),
- Odvodno slabljenje <2 dB, sprega TV/FM >20 dB
- Male connector TV, female connector FM,
- SAT connector IEC 60169-24 (F type),
- Connection attenuation <2 dB, coupling attenuation TV/FM >20 dB

Bela  
White **x = 0**

Crna soft  
Soft black **x = E1**

Silver  
Silver **x = S**





## DEKORATIVNE MASKE DECORATIVE FRAMES

- Usaglašeno sa IEC 60669-1 i IEC 60884-1,
- Za ugradnju na EON mehanizme ugrađene u zid u nizajuće dozne za višestruke maske (osno rastojanje 71 mm)

- Complied with IEC 60669-1 and IEC 60884-1,
- For mounting onto EON mechanisms wall mounted in a sequence of boxes for multiple masks (axial distance 71 mm)

### JEDNOSTRUKA MASKE ONE-GANG FRAMES



**E6801.00**  
Maska jednostruka  
80 x 80mm EON  
*One-gang frame  
80 x 80mm EON*



**E6803.00**  
Maska jednostruka  
EON 80 x 120mm  
*One-gang frame  
EON 80 x 120mm*



**E6803U.00**  
Maska jednostruka  
EON 80 x 120mm  
za uski taster  
*One-gang frame  
EON 80 x 120mm  
for narrow button*



**E6805.00**  
Maska dvostruka  
priključnice EON  
*Double-pole socket  
outlet dual frame EON*

### VIŠESTRUKA MASKE MULTI-GANG FRAMES

#### HORIZONTALNE / HORIZONTAL

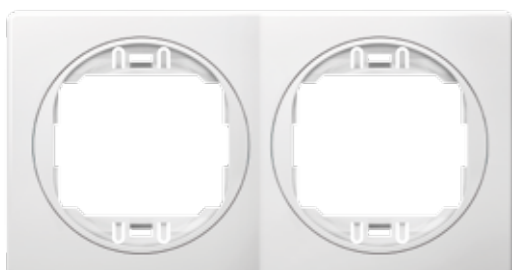

**E6701.00**  
Maska dvostruka  
EON horizontalna  
*Two-gang frame  
EON horizontal*

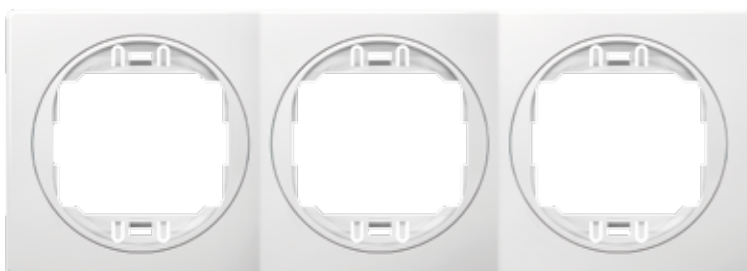

**E6703.00**  
Maska trostruka  
EON horizontalna  
*Three-gang frame  
EON horizontal*

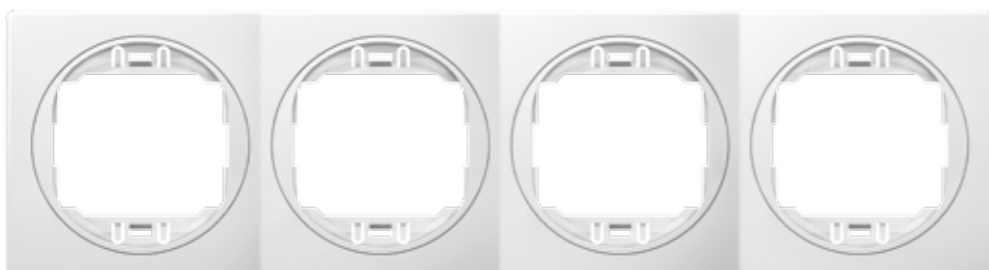

**E6704.00**  
Maska četvorostuka  
EON horizontalna  
*Four-gang frame  
EON horizontal*

#### VERTIKALNE / VERTICAL



**E6711.00**  
Maska dvostruka  
EON vertikalna  
*Two-gang frame  
EON vertical*



**E6713.00**  
Maska trostruka  
EON vertikalna  
*Three-gang frame  
EON vertical*



**E6714.00**  
Maska četvorostuka  
EON vertikalna  
*Four-gang frame  
EON vertical*





# CLASSIC

CLASSIC linija sastoji se iz tri osnovne boje: bela, crna i silver

Boja dekorativnih maski prati boje mehanizama (tastera / bloka)

*CLASSIC line consists of three basic colors: white, black and silver*

*Color of decorative frames is the same as color of mechanisms (button / block)*

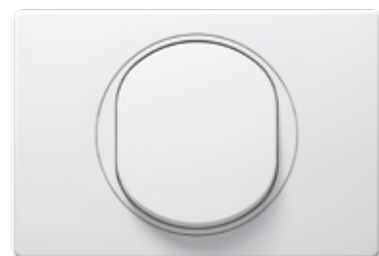



# CLASSIC

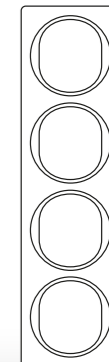
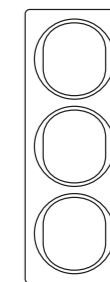
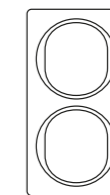
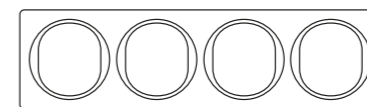
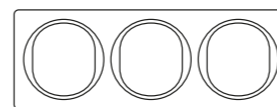
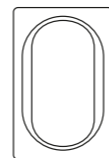
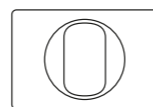
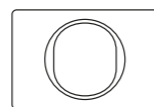
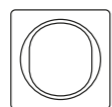

Razigrane boje koje će veselo razbuditi svaki prostor.

*Playful colors that will happily wake up every space*





# COLOR

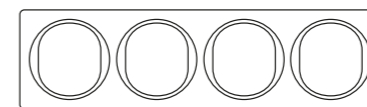
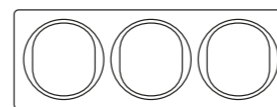
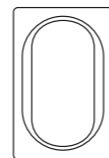
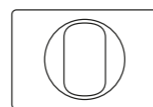
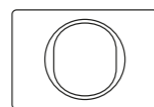
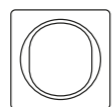

Lavanda maska  
Beli nosač  
*Lavander frame  
White holder*



**E6801.V0**

**E6803.V0**

**E6803U.V0**

**E6805.V0**

**E6701.V0**

**E6703.V0**

**E6704.V0**

**E6711.V0**

**E6713.V0**

**E6714.V0**

Pastel zelena maska  
Beli nosač  
*Pastel green frame  
White holder*



**E6801.70**

**E6803.70**

**E6803U.70**

**E6805.70**

**E6701.70**

**E6703.70**

**E6704.70**

**E6711.70**

**E6713.70**

**E6714.70**

Krem maska  
Crni nosač  
*Beige frame  
Black holder*



**E6801.9E**

**E6803.9E**

**E6803U.9E**

**E6805.9E**

**E6701.9E**

**E6703.9E**

**E6704.9E**

**E6711.9E**

**E6713.9E**

**E6714.9E**

Crvena maska  
Crni nosač  
*Red frame  
Black holder*



**E6801.4E**

**E6803.4E**

**E6803U.4E**

**E6805.4E**

**E6701.4E**

**E6703.4E**

**E6704.4E**

**E6711.4E**

**E6713.4E**

**E6714.4E**

# METALLIC

Za prostore sa dozom  
metalnog odsjaja

*For spaces with a touch  
of metallic reflection*





# METALLIC

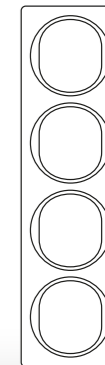
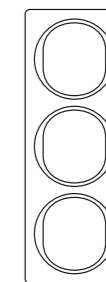
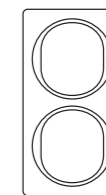
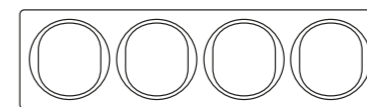
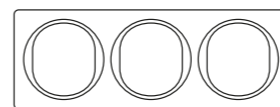
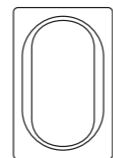
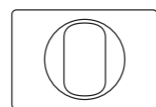
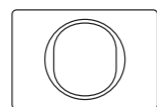
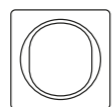

Brušeni nikal maska  
Crni nosač  
*Brushed nickel frame  
Black holder*



**E6801.G2E**

**E6803.G2E**

**E6803U.G2E**

**E6805.G2E**

**E6701.G2E**

**E6703.G2E**

**E6704.G2E**

**E6711.G2E**

**E6713.G2E**

**E6714.G2E**

Antičko srebro maska  
Crni nosač  
*Antic silver frame  
Black holder*



**E6801.S1E**

**E6803.S1E**

**E6803U.S1E**

**E6805.S1E**

**E6701.S1E**

**E6703.S1E**

**E6704.S1E**

**E6711.S1E**

**E6713.S1E**

**E6714.S1E**

Zlatna maska  
Crni nosač  
*Gold frame  
Black holder*



**E6801.GE**

**E6803.GE**

**E6803U.GE**

**E6805.GE**

**E6701.GE**

**E6703.GE**

**E6704.GE**

**E6711.GE**

**E6713.GE**

**E6714.GE**

# SOFT TOUCH

Jednostavan,  
nežan na dodir

*Simple,  
gentle touch*

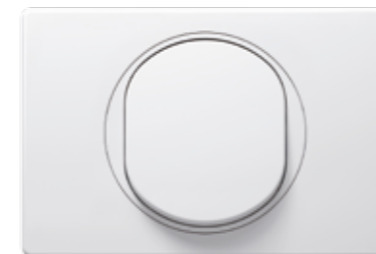



# SOFT TOUCH

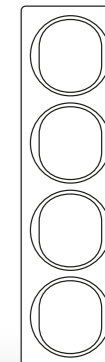
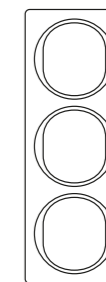
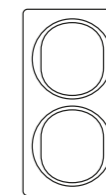
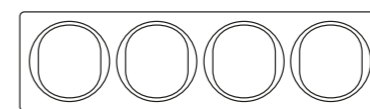
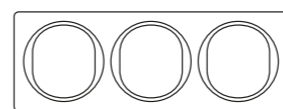
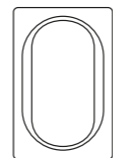
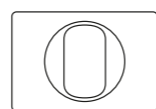
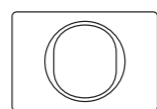
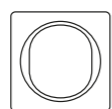

Bela maska soft touch  
Beli nosač  
White frame soft touch  
White holder



**E6801.K20**

**E6803.K20**

**E6803U.K20**

**E6805.K20**

**E6701.K20**

**E6703.K20**

**E6704.K20**

**E6711.K20**

**E6713.K20**

**E6714.K20**

Bela maska soft touch  
Silver nosač  
White frame soft touch  
Silver holder



**E6801.K2S**

**E6803.K2S**

**E6803U.K2S**

**E6805.K2S**

**E6701.K2S**

**E6703.K2S**

**E6704.K2S**

**E6711.K2S**

**E6713.K2S**

**E6714.K2S**

Crna maska soft touch  
Beli nosač  
Black frame soft touch  
White holder



**E6801.E10**

**E6803.E10**

**E6803U.E10**

**E6805.E10**

**E6701.E10**

**E6703.E10**

**E6704.E10**

**E6711.E10**

**E6713.E10**

**E6714.E10**

Crna maska soft touch  
Crni nosač  
Black frame soft touch  
Black holder



**E6801.E1E**

**E6803.E1E**

**E6803U.E1E**

**E6805.E1E**

**E6701.E1E**

**E6703.E1E**

**E6704.E1E**

**E6711.E1E**

**E6713.E1E**

**E6714.E1E**

Crna maska soft touch  
Silver nosač  
Black frame soft touch  
Silver holder



**E6801.E1S**

**E6803.E1S**

**E6803U.E1S**

**E6805.E1S**

**E6701.E1S**

**E6703.E1S**

**E6704.E1S**

**E6711.E1S**

**E6713.E1S**

**E6714.E1S**





ŠEME VEZIVANJA  
WIRING DIAGRAMS

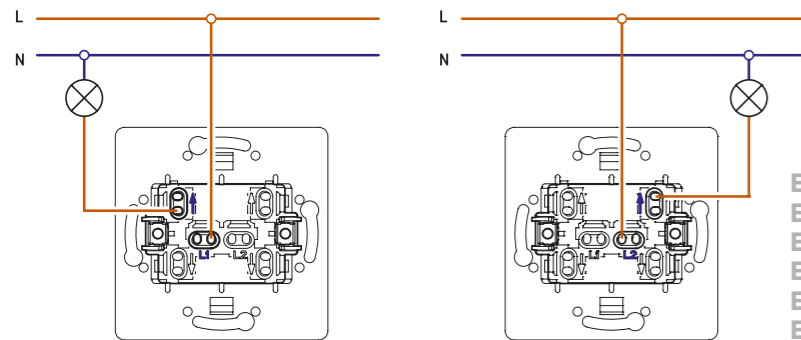

E605  
E6091  
E610  
E6101  
E625  
E619

Jednopolna sklopka ima dve izvedbe sklapanja (leva i desna) i u skladu s tim se povezuju priključni provodnici.  
Single-pole switch is supplied in two wiring executions (left and right) and the conductors are connected accordingly.

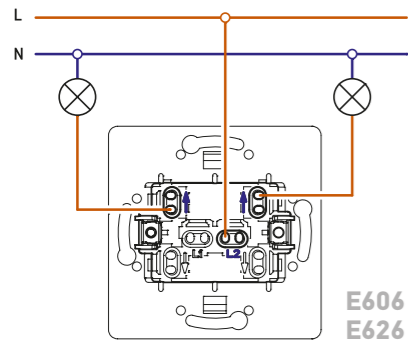

Serijska sklopka  
Serial switch

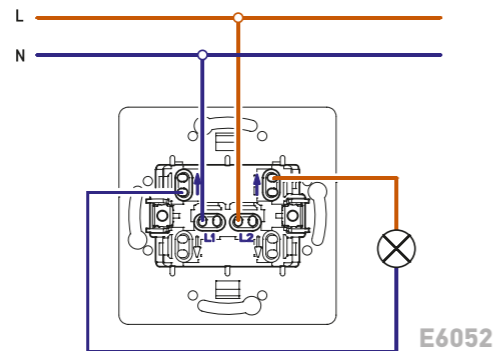

Dvopolna sklopka  
Double pole switch

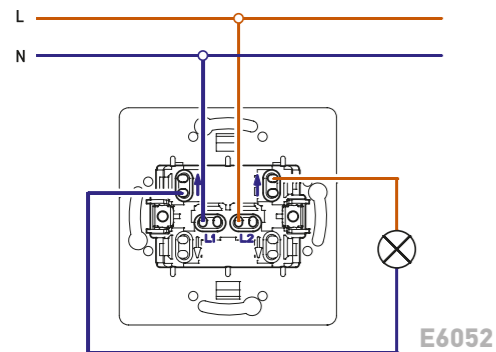

Dvopolna sklopka  
Double pole switch

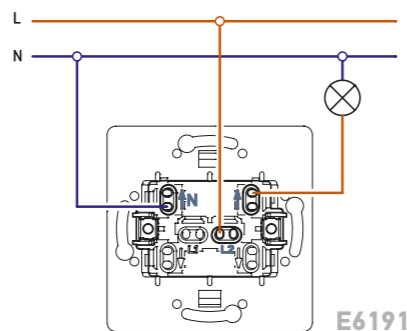

Jednopolne indikatorske sklopke (indikacija svetli kada je sklopka uključena) za povezivanje zahtevaju nulti provodnik  
Single-pole indication switches (indication turns on when the switch is on) require neutral conductor to be wired.

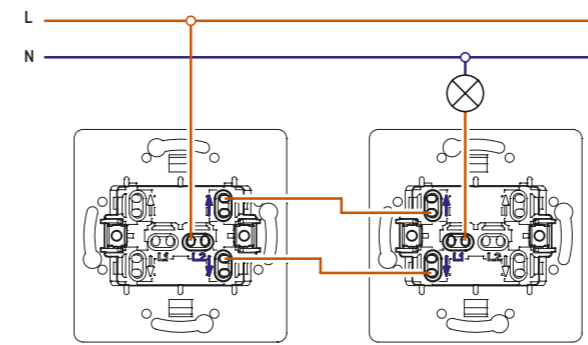

E607  
E6072  
E627

Naizmernična sklopka, dve izvedbe sklapanja (leva i desna)  
Alternative switch, two wiring executions (left and right)

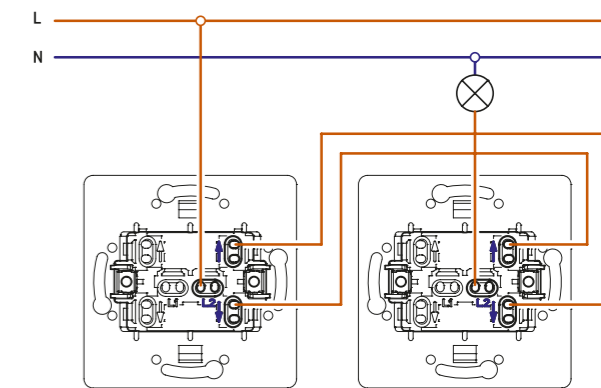

E608  
E628

Ukrsna sklopka se povezuje u kombinaciji sa naizmerničnim sklopkama. Može se povezati neograničen broj ukrasnih sklopki u kombinaciji sa dve naizmernične.

Cross-switch is wired in combination with alternative switches. The unlimited number of cross switches may be wired in combination with two alternative switches.

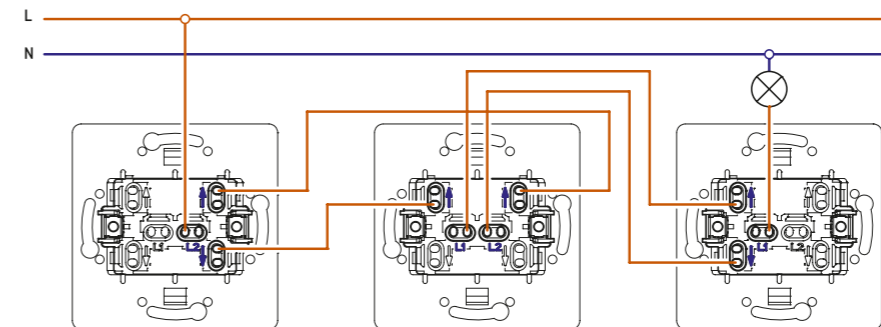

E6075

Taster sklopka za roletne  
Push-button shutters switch

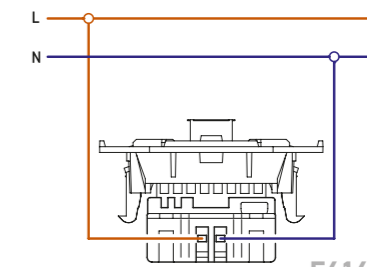

E6161

USB punjač  
USB charger

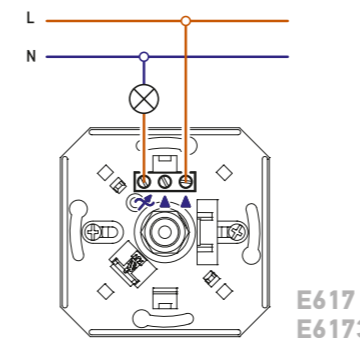

E617  
E6173

Povezivanje regulatora jačine svetlosti sa naizmerničnom sklopkom kao jednopolne sklopke i regulatora sa rotacionom jednopolnom sklopkom.  
Wiring of dimmer with alternative switch as a single-pole switch and the dimmer with rotary single-pole switch.

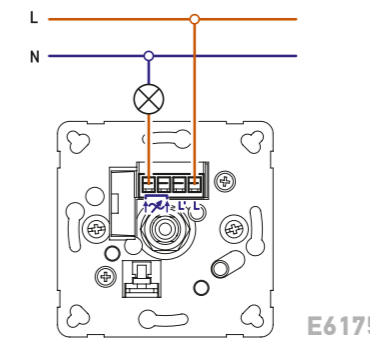

E6175

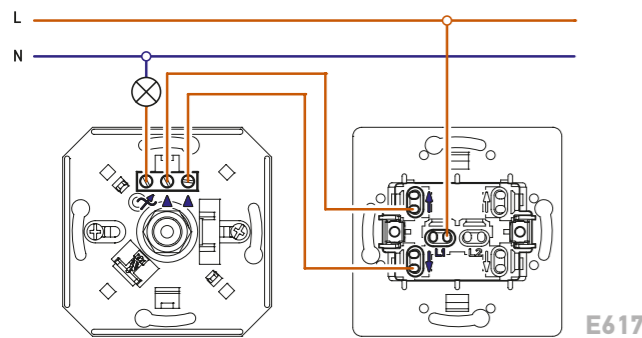

E617

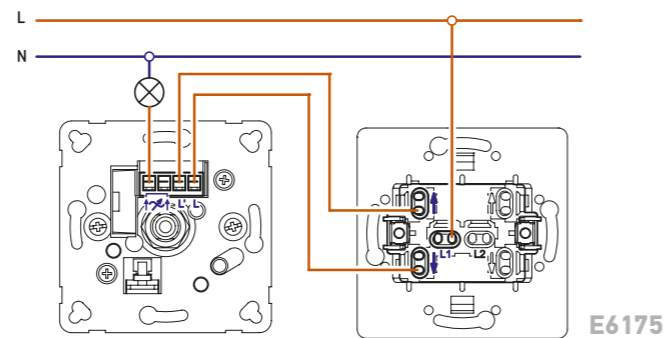

E6175

Regulator jačine svetlosti sa naizmjeničnom sklopkom može se povezivati i u kombinaciji sa naizmjeničnom sklopkom za regulaciju sa jednog mesta i uključivanje i isključivanje sa dva mesta. Međusobno povezivanje više regulatora nije moguće.

Dimmer with alternative switch may be also wired in combination with alternative switch for the regulation from one place and switching on and off from two places. Inter-wiring of more regulators is not possible.

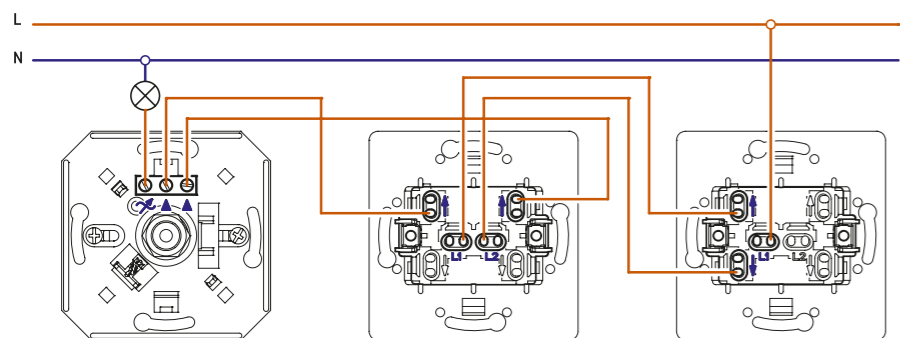

E617

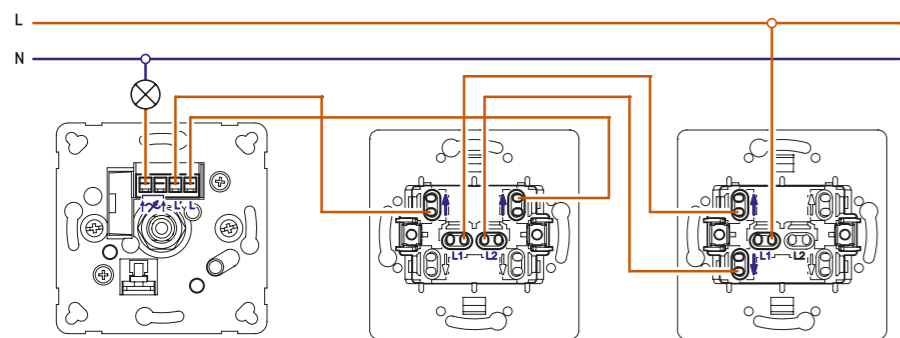

E6175

Kombinacijom regulatora sa naizmjeničnom sklopkom i ukrsne i naizmjenične sklopke omogućava se uključivanje i isključivanje sa proizvoljan broj mesta.

The combination of dimer with alternative switch and cross and alternative switch provides the switching on and off from the desirable number of places.

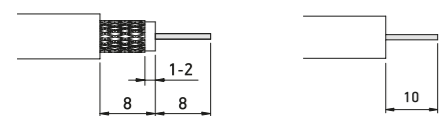

Antenski kabal za priključenje na antenske priključnice potrebno je pripremiti prema prikazanoj šemi da bi se postigao siguran kontakt, jednostavno postavljanje i onemogućio eventualni kratak spoj. For safe contact, simple installing and short-circuit disabling cable for aerial socket wiring must be prepared according showed scheme.

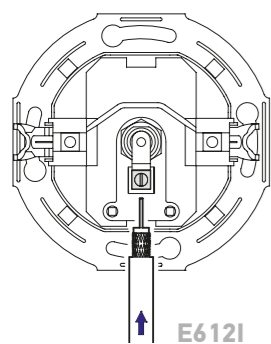

E6121

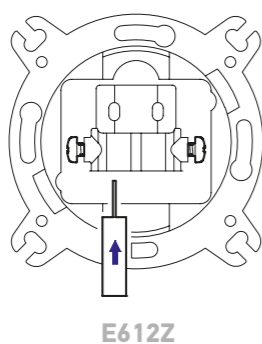

E612Z

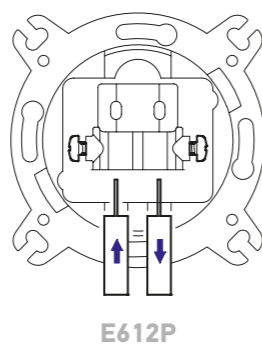

E612P

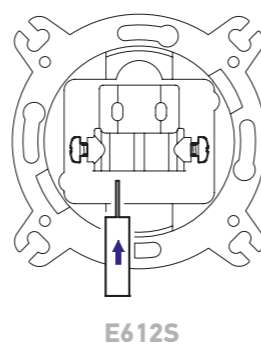

E612S

Pripremljen antenski kabal priključujemo pritezanjem u priključnu stezaljku i stezanjem oklopa kabla priteznom papučicom prema datim šemama. Prepared aerial cable may be installed into terminal and shield tightened by tightening clamp according showed scheme.

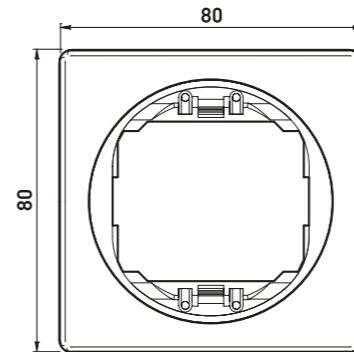

TEHNIČKI CRTEŽI  
TECHNICAL DRAWINGS

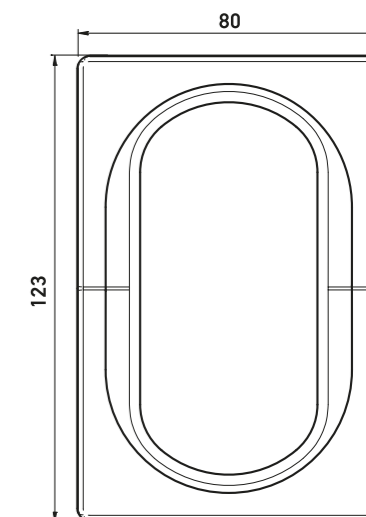
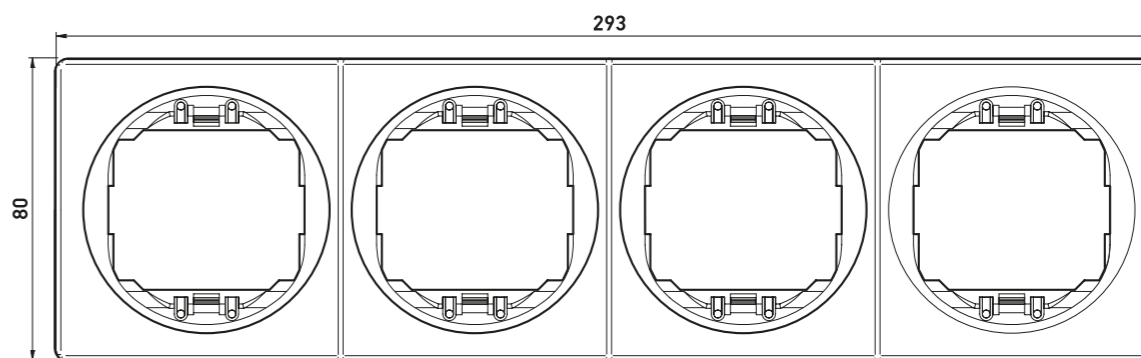
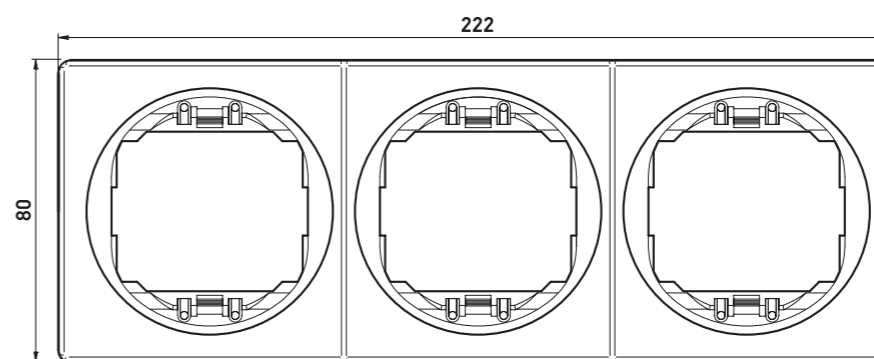
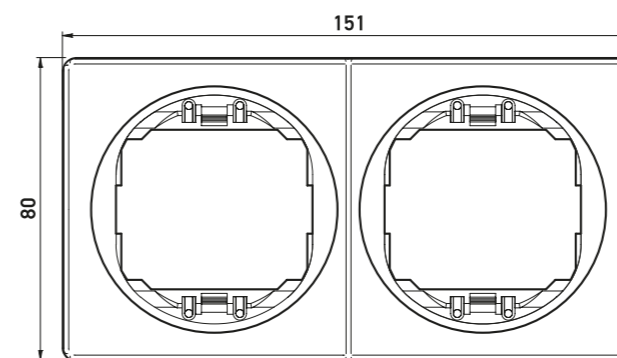
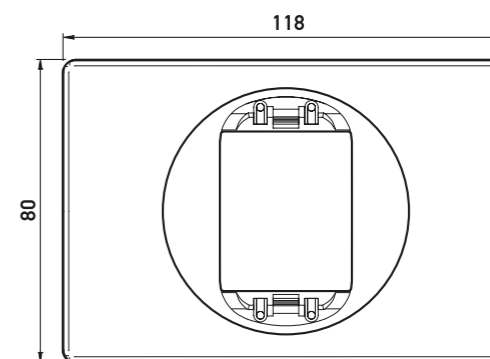
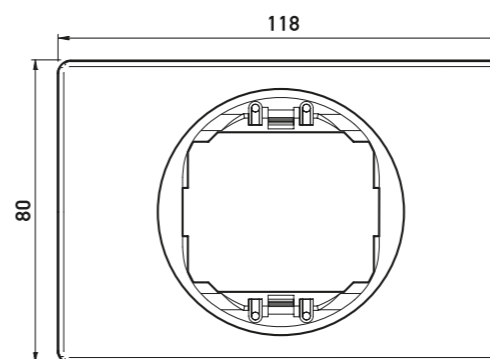



# DIMENZIJE ZA UGRADNJU INSTALLATION DIMENSIONS

- Osnova maske 80x80mm
- Cover frame base 80x80mm

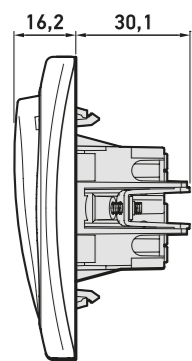

- E605
- E6052
- E606
- E607
- E6072
- E608
- E6090
- E609
- E6091
- E610
- E6101
- E625
- E626
- E627
- E6075
- E628
- E619
- E6191

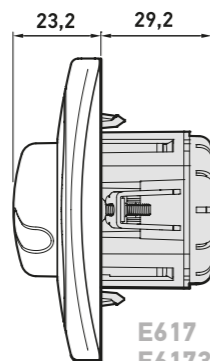

- E617
- E6173

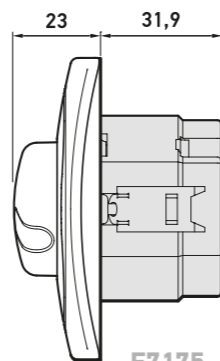

- E7175

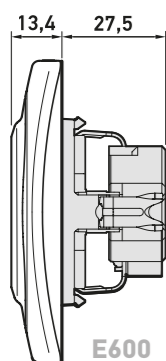

- E600
- E601

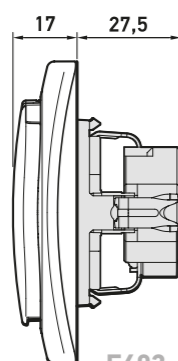

- E603

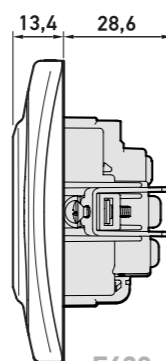

- E630

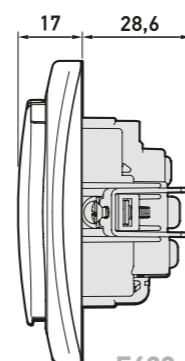

- E633

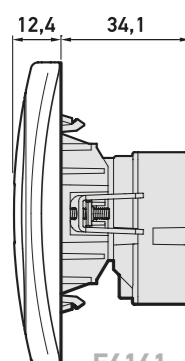

- E6161

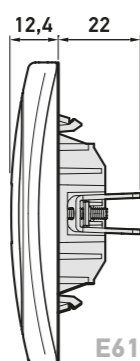

- E616
- E6162
- E6165
- E6163

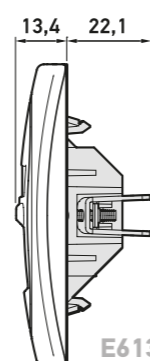

- E613
- E6131

- E614
- E614S
- E615
- E615S

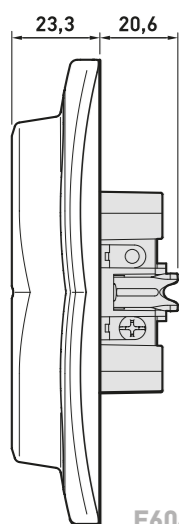

- E604

Osnova maske  
80x123mm  
Cover frame base  
80x123mm

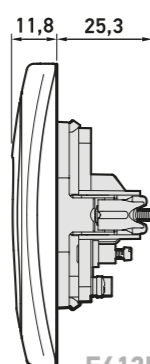

- E6121

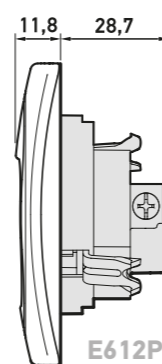

- E612P
- E612Z
- E612S



**ALING-CONEL**



**E04** 400 x 1400 mm

Reklamni pano EON

Display board EON



## REKLAMNI MATERIJAL PROMOTIONAL MATERIAL

ALING-CONEL za potrebe veleprodaja, maloprodaja i prodajnih salona nudi reklamne panoe u više dimenzija, sa originalnim proizvodima. Izgled panoa može da varira u zavisnosti od proizvoda koji se na njima prikazuju.

*Ideally suitable for wholesales, retails and showrooms ALING-CONEL provides display boards with original devices. The layout of display boards might be changed caused by product changes.*



**E03** 400 x 800 mm

Reklamni pano EON

Display board EON



**E02** 200 x 750 mm

Reklamni pano EON

Display board EON



**E05**

Promo kutija EON

Promo box EON

Kutija sa odabranim proizvodima i dekorativnim maskama omogućava prikaz brojnih kombinacija boja i dizajna brenda EON. Kutija je uradena u kvalitetnom plastificiranom kartonu sa dekorativnom štampom.

*Promo box with chosen products and decorative frames is designed to show variety of color combinations and design of EON brand. Promo box is made of high quality cardboard with decorative print.*



SADRŽAJ KATALOGA  
THE CATALOG CONTENT

- 9 BELI PROGRAM 80X80 SKLOP  
WHITE PROGRAM 80X80 SET
- 10 SKLOPKE  
SWITCHES
- 12 ELEKTRONIKA  
ELECTRONICS
- 13 PRIKLJUČNICE  
SOCKET OUTLETS
- 14 KOMUNIKACIJE  
COMMUNICATIONS
- 17 MEHANIZMI BEZ MASKE  
MECHANISMS WITHOUT COVER FRAME
- 22 USKI TASTER  
NARROW BUTTON
- 29 DEKORATIVNE MASKE  
DECORATIVE FRAMES
- 32 CLASSIC
- 36 COLOR
- 40 METALLIC
- 44 SOFT TOUCH
- 48 ŠEME VEZIVANJA  
WIRING DIAGRAMS
- 51 TEHNIČKI CRTEŽI  
TECHNICAL DRAWINGS
- 52 DIMENZIJE ZA UGRADNJU  
INSTALATION DIMENSIONS
- 53 REKLAMNI MATERIJAL  
PROMOTIONAL MATERIAL





# **ALING-CONEL**

a: Železnička 10, 21432 Gajdobra, Serbia  
t: +381 21 762 674, 762 586  
f: +381 21 762 779  
e: [sales@aling-conel.com](mailto:sales@aling-conel.com)  
[www.aling-conel.com](http://www.aling-conel.com)